

TZ-8 立式限位开关

Vertical Limit Switch

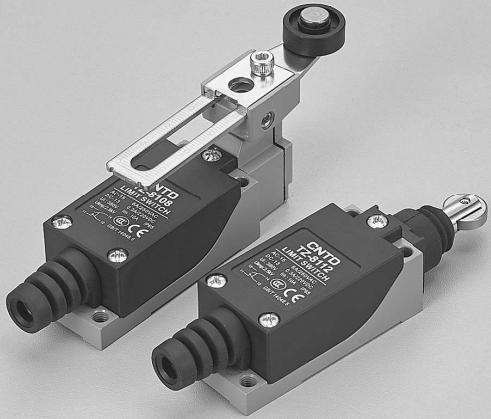

特点 Features

- 双回路型限位开关
- 结构坚固, 由锌合金及强化塑胶组成
- 体积小, 可防水、防油
- 内藏触点座有双簧片机构, 机械寿命更长
- 具有较大的过行程
- 使配线更加简易的导管设计
- 引动器种类多, 方便使用
- Double circuit type of limit switch
- High mechanical strength, consists of intensive plastic and aluminum cast
- Small size, water-proof and oil-proof construction
- Built-in contact box has double-spring and long mechanical life
- Smooth operation with larger over travel distance
- Conduit design for convenient cabling
- Various actuators for different applications

接点型式 Contact Form



额定值 Ratings

额定电压 Rated Voltage	非电感性负载 Noninductive Load (A)				电感性负载 Inductive Load (A)			
	电阻性负载 Resistance Load		灯泡负载 Lamp Load		电感性负载 Inductive Load		马达负载 Motor Load	
	NC	NO	NC	NO	NC	NO	NC	NO
125VAC	5	5	1.5	0.7	3	3	2	1
250VAC	5	5	1	0.5	3	3	1.5	0.8
8VDC	5	5	3	3	5	4	3	3
14VDC	5	5	3	3	4	4	3	3
30VDC	5	5	3	3	4	4	3	3
125VDC	0.4	0.4						
250VDC	0.2	0.2						
突入电流 Inrush Current	N.C.:24A 以下, N.O.:12A 以下 N.C.: below 24A, N.O.: below 12A							

- 注: 1. 电感性负载之功率因素在 0.4 以上 (AC), 时间常数在 7msec 以下 (DC).
 2. 灯泡负载之突入电流为稳定状态电流之 10 倍, 马达负载之突入电流为稳定状态电流之 6 倍.
 3. 带弹簧系列产品, 操作体的使用范围为从弹簧的前端到弹簧全长的 1/3 以内.

NOTES: 1. Inductive load has a power factor of 0.4 min.(AC) and a time constant of 7 msec. max.(DC).
 2. Lamp load has an inrush current of 10 times the steady-state current, while motor load has an inrush current of 6 times the steady-state current.
 3. Product with spring, its usable range of operating part is within one third of the whole spring length from the front end of spring.

动作特性 Operating Characteristics

型号 Model	TZ-8	TZ-8104 TZ-8105	TZ-8108 TZ-8109	TZ-8107	TZ-8111	TZ-8112/8122	TZ-8166/8167/8168/8169
操作力 Operating force	OF(最大)(Max.)	750g	750g	100g	900g	900g	150g
回弹力 Release force	RF(最小)(Min.)	100g	100g	100g	150g	150g	-
预行程 Pre-travel	PT(最大)(Max.)	20°	20°	20°	1.5mm	1.5mm	30mm
过行程 Over travel	OT(最小)(Min.)	50°	50°	50°	4mm	4mm	-
行程移动分辨率 Movement differential	MD(最大)(Max.)	12°	12°	12°	1mm	1mm	-
动作位置 Operating position	OP(mm.)	-	-	-	26 ± 0.8mm	37 ± 0.8mm	-

TZ-8 立式限位开关

Vertical Limit Switch

外观和尺寸 Appearance and Dimension

TZ-8104

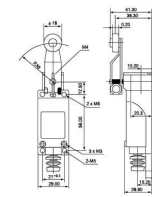

TZ-8105

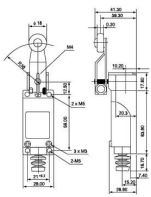

TZ-8107

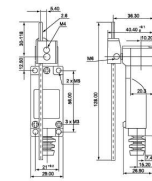

TZ-8108

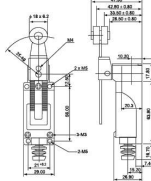

TZ-8109

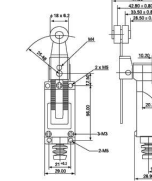

TZ-8111

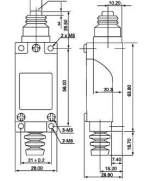

TZ-8112

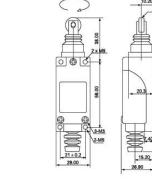

TZ-8122

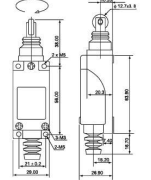

TZ-8166

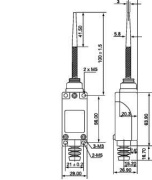

TZ-8167

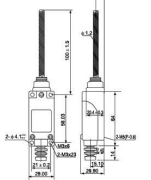

TZ-8168

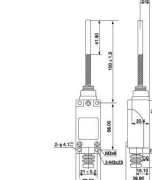

TZ-8169

